









<p>(A1) = 36pcs</p>  <p>L-35</p>	<p>(A2) = 4pcs</p>  <p>L-40</p>	<p>(B1) = 22pcs</p> 	<p>(B3) = 18pcs</p>  <p>[H-13]</p>	<p>(B4) = 4pcs</p>  <p>[H-10]</p>	<p>(Z10) = 22pcs</p> 
<p>(R1) = 4pcs</p> 	<p>(G1) = 5pcs</p> 	<p>(W3) = 21pcs</p>  <p>3,5x16</p>	<p>(W1) = 8pcs</p> 	<p>(P5) = 1set Push to open</p>  <p>268mm</p>	
	<p>(ST1) = 5pcs</p> 	<p>(T1) = 1pc</p> 	<p>(K1) = 1pc</p> 		

1

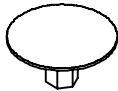
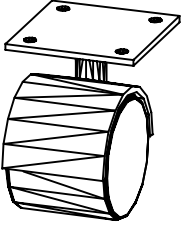

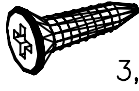
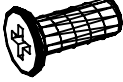
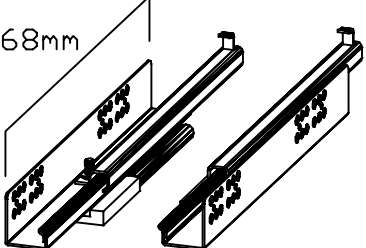
2

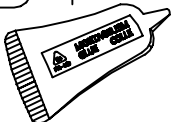
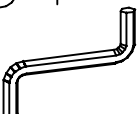
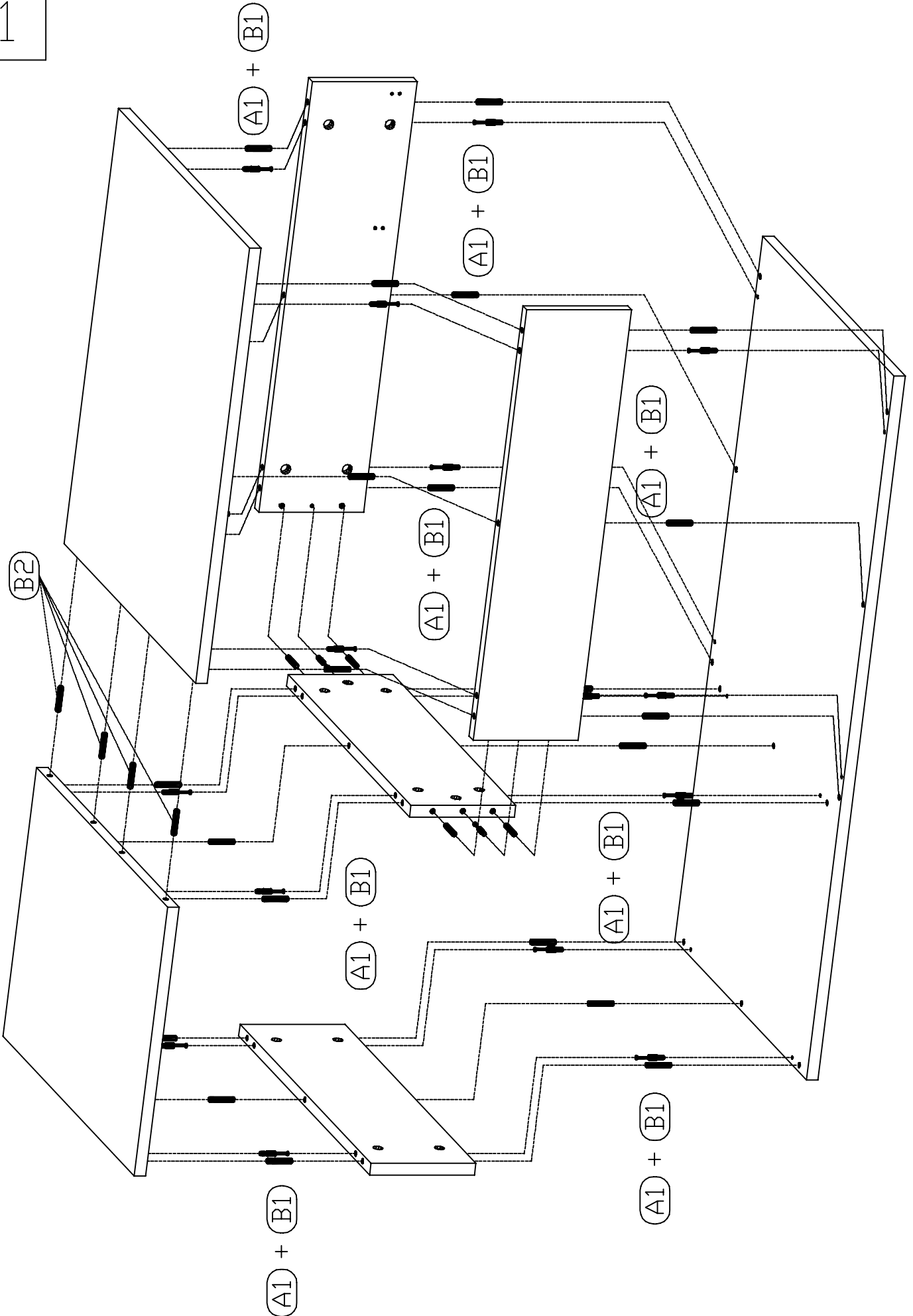
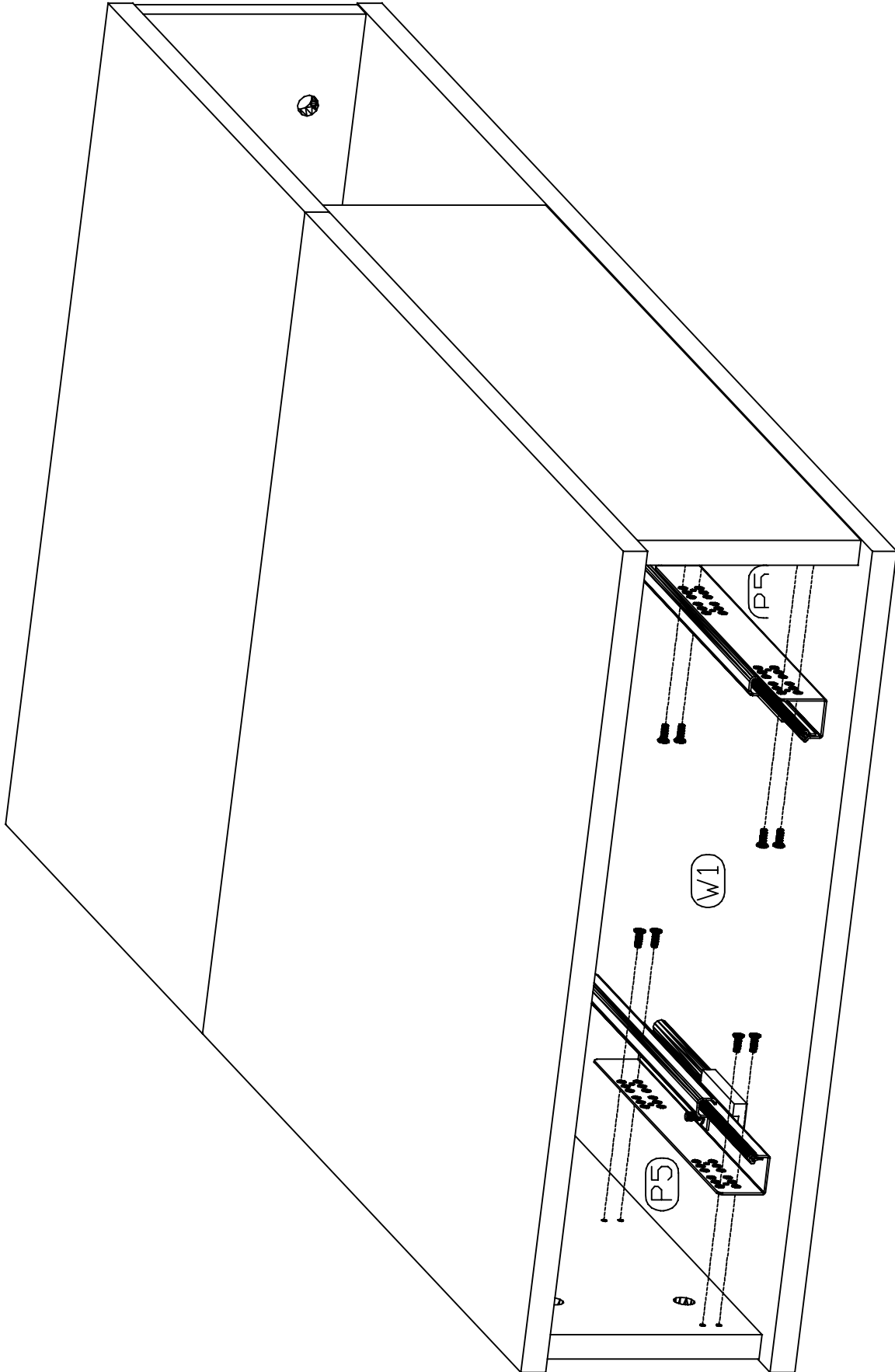

3

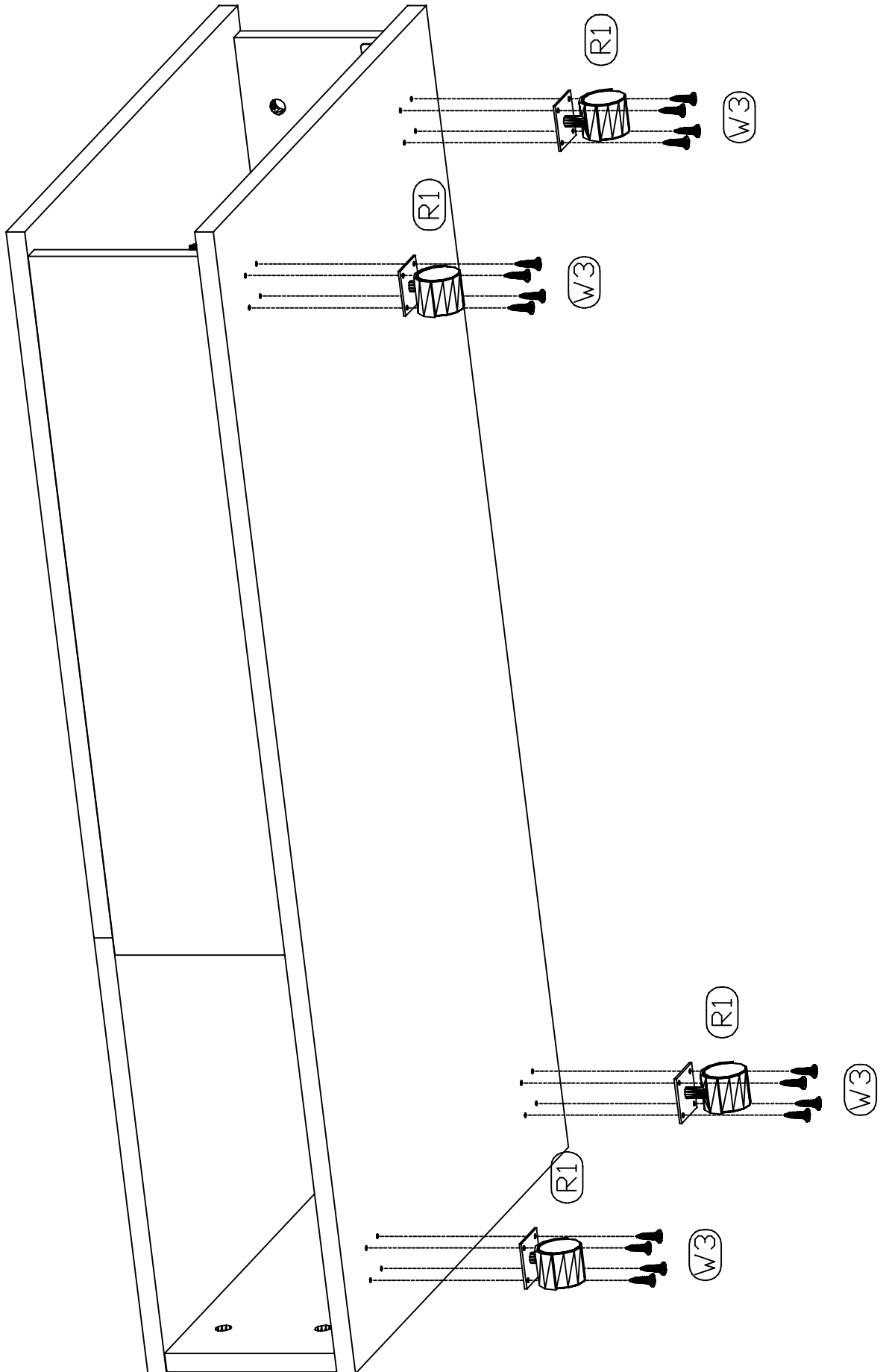

4

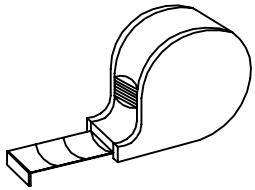
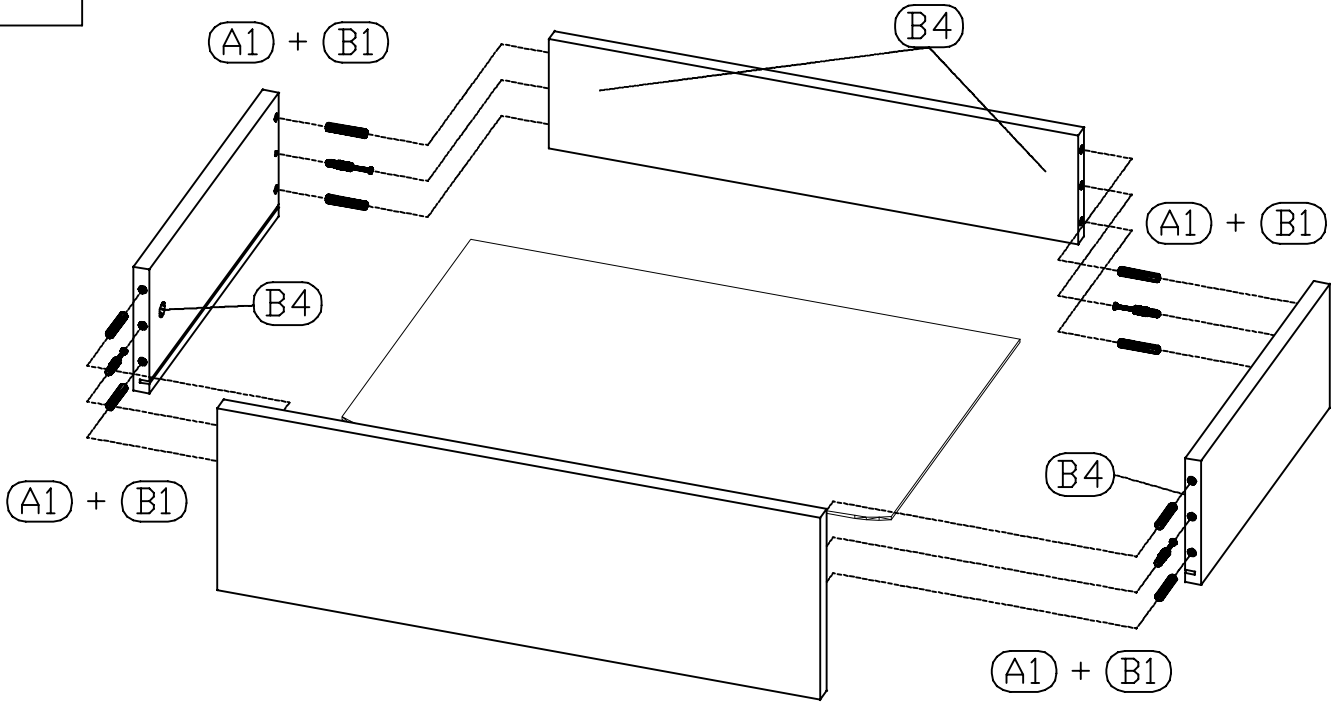

$a = b$

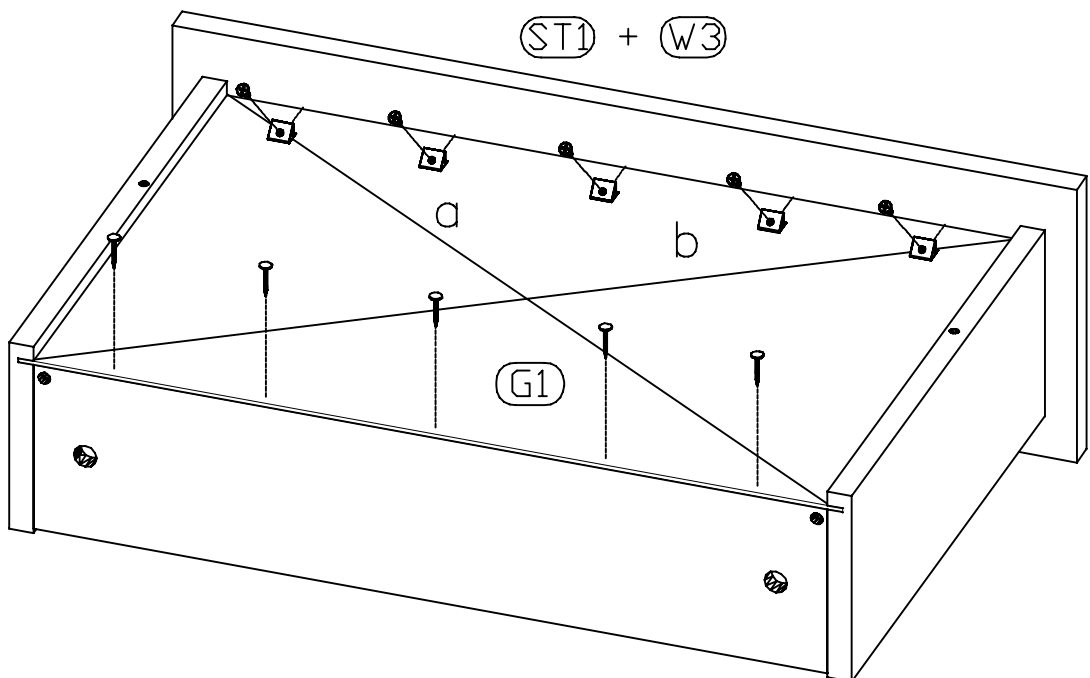

5

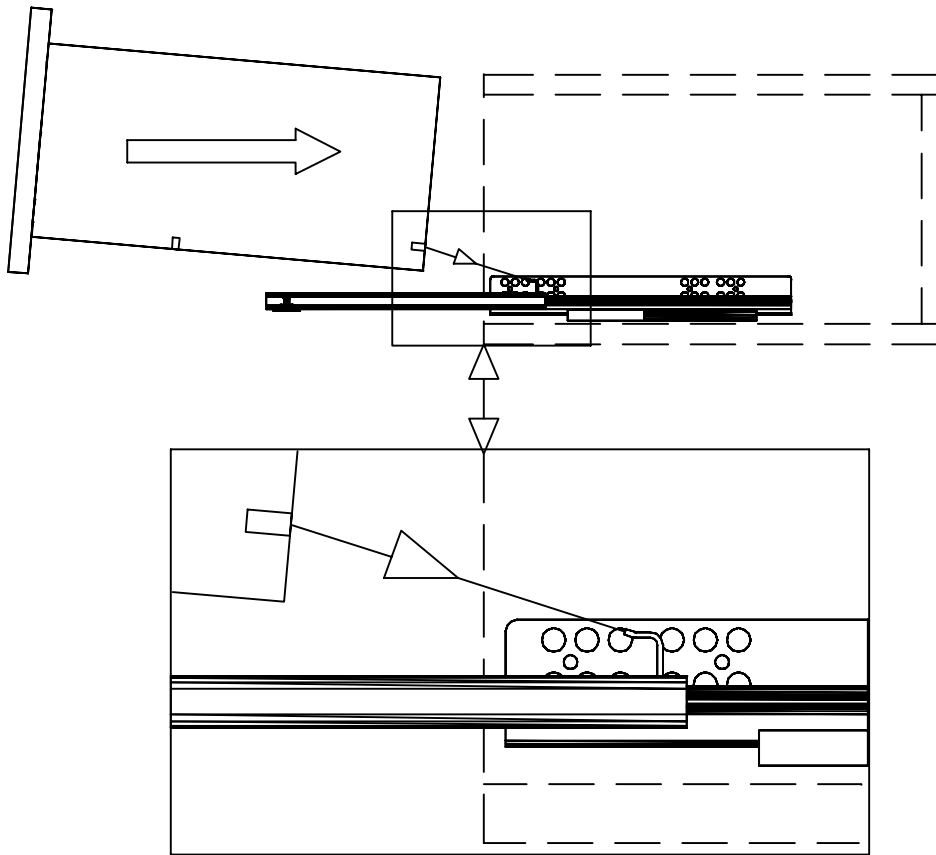

6

